

Faster Illuminance Convergence for the Intelligent Lighting System Using Visible Light Communication

Mitsunori MIKI

Department of Science and Engineering
Doshisha University
Kyoto, Japan
Email: mmiki@mail.doshisha.ac.jp

Kenta YOSHIDA

Graduate School of Science and Engineering
Doshisha University
Kyoto, Japan
Email: kyoshida@mikilab.doshisha.ac.jp

Masato YOSHIMI

Department of Science and Engineering
Doshisha University
Kyoto, Japan
Email: myoshimi@mail.doshisha.ac.jp

Hiroataka Ito

Graduate School of Science and Engineering
Doshisha University
Kyoto, Japan
Email: hito@mail.doshisha.ac.jp

Masashi Nagano

Department of Science and Engineering
Doshisha University
Kyoto, Japan
Email: mnagano@mail.doshisha.ac.jp

Abstract—We have been proposing the Intelligent Lighting System that can provide specific sections of the office space with lightings of varying illuminance. Using the influence of lightings on illuminance sensors, the system can satisfy the required lighting conditions within a few minutes. However, in some cases a spot must be lit up more quickly. In this research, we propose an improvement to the Intelligent Lighting System that uses visible light communication to achieve direct communication between the lights and illuminance sensors. We confirmed that the new system is able to make illuminance converge to a preset target in considerably shorter times and that it can respond adaptively to the movements of illuminance sensors.

Index Terms—Lighting Control, Optimization, Office Environment, Illuminance, Visible Light Communication

I. INTRODUCTION

In recent years, as information system technologies develop, more and more systems are made to be intelligent, in that they adapt their behavior and management to the user or environment, thus making tasks easier for humans. However, lighting systems, despite their importance in our everyday lives, have yet to see much intelligence.

With current lighting systems, lighting patterns depend heavily on the placement of switches and cables, making it difficult to light up in a given pattern. Also, they tend to consume too much power especially in modern offices where many of the workers are using LCDs. This must be dealt with, for lighting is responsible for more than 20% of the energy consumption in a typical office building.

In light of these circumstances, researches of autonomous lighting systems are under way to achieve complex lighting patterns and lower power consumption. One such system is the self-control system. In the self-control system, illuminance sensors embedded in lights sense the reflections of the installed and external lights, and use the values to control the dimmers. The system can keep the illuminance of the desktops to a certain value and the light emission to a minimum, thus

lowering power consumption. However, systems of this type use fixed sensors and control lightings in groups, which makes it unsuitable for providing a given amount of light for a given spot.

Meanwhile, we are researching and developing a new type of system (the Intelligent Lighting System) to tackle this problem[1],[2]. The Intelligent Lighting System provides a given spot with a given illuminance by distributed autonomous control. In earlier papers we have proposed ANA/CC (Adaptive Neighborhood Algorithm using Correlation Coefficient) as a control algorithm for this system[3]. This algorithm is based on SHC (Stochastic Hill Climbing), a type of generic optimization strategy. Given multiple constraints concerning illuminance, this algorithm computes a combination of luminances with the minimum amount of overall power consumption. In order to perform this optimization efficiently, the system estimates the spatial relationships of lights and illuminance sensors from the correlation of light luminance and sensor illuminance values.

We have confirmed the basic capabilities of the Intelligent Lighting System in previous laboratory experiments. In a room with 15 lights, the system was able to achieve a lighting pattern that satisfies the requirements of 3 different users and, at the same time, consumes the least possible power. Convergence to this pattern was done in approximately 2 minutes. Convergence time did not differ significantly in another large-scale setting involving 26 lights and 22 illuminance sensors. However, because the Intelligent Lighting System learns the spatial relationships while computing correlation coefficients, it takes approximately the same amount of time (2 minutes) when an illuminance sensor is moved from a bright spot to a dim spot, in which case the new spot must be lit up[4]. In office environments, this would not pose a practical problem if the new spot is originally 300[lx] or brighter (a JIS defined illuminance standard), but otherwise this slow convergence may disrupt work.

To resolve this issue, we shall obtain the spatial relationships of lights and sensors more directly, thus lighting up the required lights more quickly.

Common methods of localization include GPS, wireless LAN, ultrasonic waves, infrared rays, and more recently, visible light communication (VLC) using LEDs[5],[6]. GPS and wireless LAN technologies are unsuitable for our case because the premises are indoors and we need an accuracy of approximately 10[cm], which these technologies are unable to provide. Ultrasonic waves, infrared rays and VLC are all viable options because they yield sufficient accuracy in indoor settings. VLC, in particular, could prove to be especially low-cost, since LEDs are gaining popularity as the new mainstream lighting devices, and those LEDs can act simultaneously as transmitters for VLC.

Therefore we have formulated a method in which the lights convey their own IDs to illuminance sensors via VLC. The sensors can recognize the IDs when they are within 1[m] of the point below a given light. Our new Intelligent Lighting System incorporates this data in its algorithm, making convergence faster.

II. INTELLIGENT LIGHTING SYSTEM

A. Overview

The Intelligent Lighting System satisfies users' required illuminance by collaboration of its lighting devices. Such system typically consists of multiple lighting devices, mobile illuminance sensors, and electric power meters.

Lighting apparatus are equipped with control devices capable of machine learning, and each light behaves independently and autonomously. Lighting patterns for conventional lighting systems were limited to their installed wire patterns, whereas the Intelligent Lighting System can provide any given pattern regardless of how the lights are wired.

B. Lighting Control Algorithm

The algorithm we use is called ANA/CC (Adaptive Neighborhood Algorithm using Correlation Coefficient)[3]. This algorithm computes the correlation coefficients of the luminance of a light against multiple illuminance sensors by performing correlation analyses of change rates in luminance and illuminance.

In a light controlling algorithm, it is helpful to have determined how the lights are positioned against the illuminance sensors. Correlation analysis is an effective way of autonomously learning these spatial relationships.

C. Methods of Localization

In the Intelligent Lighting System, localization does not need to be done in wide range, but must be able to be performed indoors and provide sufficiently accurate estimates of spatial relationships among lights and illuminance sensors.

Currently, common methods for localization include GPS, wireless LAN, ultrasonic waves, infrared rays and VLC. Of these, GPS is unsuitable for indoor settings. Wireless LAN is accurate to merely 1 or 2[m] whereas our system would require

accuracy to approximately 10[cm]. Ultrasonic waves, infrared rays and VLC are all viable options for determining the positions of illuminance sensors. In particular, VLC is promising since it can be easily embedded in LEDs. LEDs are gaining popularity as replacements for fluorescent and other ceiling lights, which means that the ceiling lights themselves may double as transmitters of VLC, being highly cost-effective.

Assuming the lights themselves are used as VLC devices, illuminance sensors would be able to receive the lights' IDs when placed within 1[m] of the spot directly under the lights. In other words, a sensor is close to a light if it can receive its ID.

Therefore, in this study we discuss localization using VLC to improve the lighting control algorithm in the Intelligent Lighting System.

III. INTRODUCING VLC TO THE INTELLIGENT LIGHTING SYSTEM

A. Overview

With the development of LED technologies, VLC is gaining popularity. VLC uses ordinary lights, blinking them at speeds unrecognizable to the human eye, to communicate data. We incorporated this technique into the Intelligent Lighting System: lights transmit their own ID numbers, enabling illuminance sensors to directly recognize nearby lights.

The conventional Intelligent Lighting System estimates the spatial relationships of lights and sensors by randomly changing the luminances and analyzing the correlation between changes in luminance and changes in illuminance sensor values. With VLC, these complex computations are no longer necessary. Fig.1 shows the system overview. Compare the conventional Intelligent Lighting System and VLC for some items.

- Cost
VLC needs to set an ID number as each light. Therefore, initial cost for VLC is higher than the conventional Intelligent Lighting System.
- System Robustness
When a light doesn't transmit its ID over VLC, the Intelligent Lighting System uses ANA/CC.
- Energy Consumption
When a light lit, it transmits its ID over VLC. Therefore, the amount of energy consumption used VLC is the same as that used the conventional Intelligent Lighting System.

Each light is given an ID number. When a light is lit, it transmits its ID over VLC periodically. Illuminance sensors, equipped with VLC receiver functionalities, keep receiving the lights' IDs. This allows the lights and the sensors to communicate directly with each other. In the conventional Intelligent Lighting System, the data that the sensors transmitted over the network consisted of their sensor IDs, target illuminances, and the current illuminance. In the new system, the light IDs received are added to this set of data.

Any light whose ID was received by a sensor must be close to the sensor. We shall call these IDs the neighboring light IDs. Data received by the lights are as shown in Table I. Each light

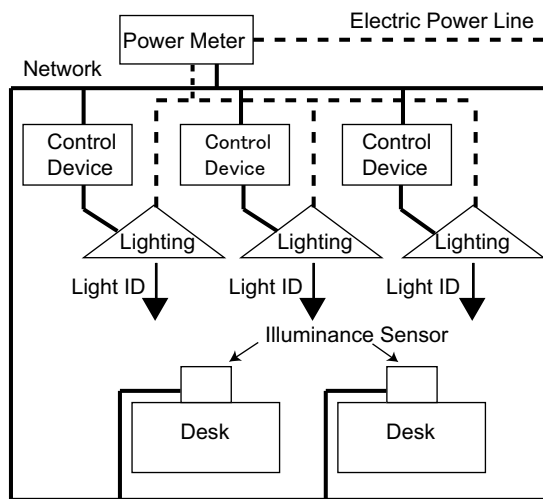

Fig. 1. Setup of the intelligent lighting system using VLC.

TABLE I
DATA OF THE ILLUMINANCE SENSORS.

Sensor ID	Target illuminance [lx]	Current illuminance [lx]	Neighboring light ID	
1	800	450	1	4
2	600	400	1	
...				
N	450	500	10	13

then matches the neighboring light IDs with its own ID. If there is a match, the light and the sensor are close to each other.

This information, in conjunction with the correlation coefficients, are then used to optimize the lighting pattern.

B. Rapid brightening

The new control algorithm for the Intelligent Lighting System uses ANA/CC described in Section II-B together with VLC. It uses data sent from illuminance sensors as shown in Table I. Fig.2 shows the flow of the algorithm, which we explain in detail below.

The gray boxed section in 2 shows what is added to the conventional algorithm. The steps are: the matching of light IDs, updating the correlation coefficients, rapid brightening decision, and rapid brightening. We shall describe each step below.

- Matching light IDs

After a light receives data from illuminance sensors via the network, it checks whether there are any sensors with neighboring light IDs that match the ID of the light itself. Because the lights transmit their IDs periodically, the sensors, while being moved around, sometimes receive inappropriate light IDs: ones that are not in the vicinity of the destination and should not be used for control purposes. In order to determine whether a received light ID is temporary or final, the neighboring light IDs are checked again after a few seconds. If the neighboring light IDs are still the same after re-checking, they are accepted as the final IDs. The length of the wait is determined by how long a user would take at maximum to move across an effective VLC range. This policy allows us to disregard

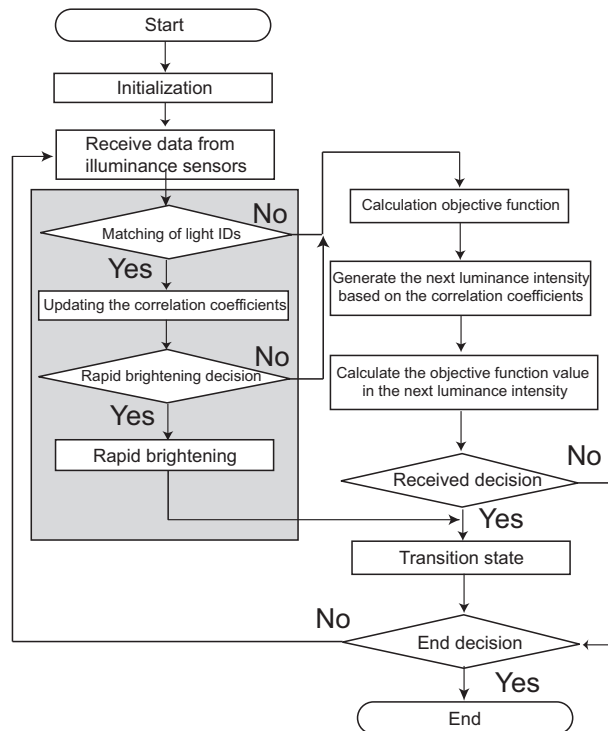

Fig. 2. Control algorithm.

temporary light IDs that were only received while moving from one point to another.

When none of the neighboring light IDs match the light's own ID, there are no illuminance sensors around the light that would be affected much by it, so the light is to behave in the conventional way.

- Updating correlation coefficients

If a light has sensors that have its own ID as a neighboring light ID (we shall call these sensors neighboring illuminance sensors), that sensor is in close proximity to the light, and the effect of the light on the sensor is strong. In that case, we set a fixed value 0.9 as the correlation coefficient for the light and the sensor and commence the conventional operation.

Correlation coefficients takes values between 0.5 and 1.0 when a light has large effects on a sensor. The larger this value, the faster the convergence of luminance, so this value must be determined experimentally. Here, sensors must be within 1[m] of the spot directly under the lights to receive their IDs, which is practically right under the lights.

- Rapid brightening decision

Of the neighboring illuminance sensors, the light chooses the one with the lowest target illuminance, and checks if the current illuminance is more than a certain amount lower than the target illuminance. Here we used 50[lx] as the threshold. If this is true, then that spot is considerably underlit. Hence, this condition decides whether or not to perform rapid brightening. If this is false, the light is to behave in the conventional way.

For example, suppose that the lights received a certain

set of data from the sensors, of which the data containing light ID 1 were as shown in Table II.

TABLE II
DATA FROM THE ILLUMINANCE SENSORS.

Sensor ID	Target illuminance [lx]	Current illuminance [lx]	Neighboring light IDs	
1	800	450	1	4
2	600	400	1	

In this case, sensors 1 and 2 are the neighboring sensors for light 1. Of these, sensor 2 has the lowest target illuminance (600[lx]). The current illuminance for sensor 2 is 400[lx], which is 200[lx] lower than the target. Therefore rapid brightening should be performed.

- Rapid brightening

If an illuminance value is considerably lower than the target illuminance, as determined in the previous step, neighboring lights are brightened rapidly. This process is performed in the following two steps.

Step 1.Measuring the effect of the light on the sensor

In order to quickly determine how much brightening needs to be done, we measure how much the light affects the sensor (how much the illuminance changes as a result of changing the luminance). This is done by adding a certain percentage (say, 20%) of the full luminance to the light's current luminance and measuring the influence. The influence rate is computed with Expr.1.

$$R = \frac{\Delta I}{\Delta L} \quad (1)$$

ΔI :Change in illuminance, ΔL :Change in luminance

Note that step 2 is never performed if the target illuminance is reached as a result of step 1.

Step 2.Rapid brightening

Using the influence rate obtained in step 1, the light brightens itself so that the lowest target illuminance out of the neighboring sensors is reached. The required amount of brightening is computed with Expr.(2).

$$L_t = L_c + \frac{I_t - I_c}{R} \quad (2)$$

L_t :Luminance required to reach target illuminance, L_c :Current luminance

I_t :Target illuminance, I_c :Current illuminance, R :Influence rate

IV. EXPERIMENTS

A. VLC Prototype

When LEDs are used as lights in the Intelligent Lighting System, they can be used as VLC devices. However, as we were unable to obtain LEDs that could be used as full-fledged ceiling lights, we used fluorescent lamps instead. Because fluorescent lamps are less suitable for VLC, we created a dedicated LED VLC transmitter prototype and placed them alongside the fluorescent lamps to achieve the desired effect. Also, we created prototypes of VLC receivers and placed them alongside the sensors, although in practice the illuminance sensors themselves shall double as VLC receivers.

VLC transmitters were built with PIC microcontrollers and LEDs. The PIC microcontrollers control the LEDs to blink every 1[ms]. Data is encoded by four-value inverted pulse position modulation (I-4PPM). Blinking at a 1[ms] rate is unrecognizable to the human eye. Table III shows the specifications of the transmitter.

TABLE III
SPECIFICATIONS OF THE TRANSMITTER PROTOTYPE.

Item	Value
Central luminance [cd]	600
Light distribution angle [°]	15
Power [V]	5
ID data to be sent [bit]	14
Transmission rate [bps]	500

For the receivers, we used Panasonic's NaPiCa illuminance sensors (photo diodes) and Turtle Industry's TUSB-K02AD A/D converters. The NaPiCa illuminance sensors yield varied electrical currents depending on the illuminance. These receive the on and off values that represent the light IDs from the LEDs.

Fig.3(a) and Fig.3(b) show the transmitter and receiver prototypes.



(a) Light and transmitter

(b) Sensor and receiver

Fig. 3. VLC device prototype.

As Fig.3(a) shows, the transmitters are placed alongside the fluorescent lamps, and are given ID numbers. As Fig.3(b) shows, receivers are placed alongside the illuminance sensors. These emulate a setup where the lights and sensors themselves act as VLC devices.

We built an experimental system with these prototypes and evaluated the effectiveness of our proposed system.

B. Evaluation of Validity

1) *VLC Range*: Fig.4 shows the distribution of illuminance when a fluorescent lamp is lit at maximum and minimum luminance.

As the figure shows, the distribution varies greatly depending on the luminance. This means that as the Intelligent Lighting System attempts to satisfy required illuminances by changing the lights' luminances, effective VLC ranges of the lights change as well. However, in this experiment we do not use the dimmable lights themselves as VLC transmitters, and so cannot simulate the alteration of effective range. Hence the transmitter LEDs must be placed at appropriate positions. Because the main purpose of this experiment is to verify the validity of the proposed system when an illuminance sensor is moved from a well-lit location to another underlit position, we placed multiple LEDs with the same ID where desktop

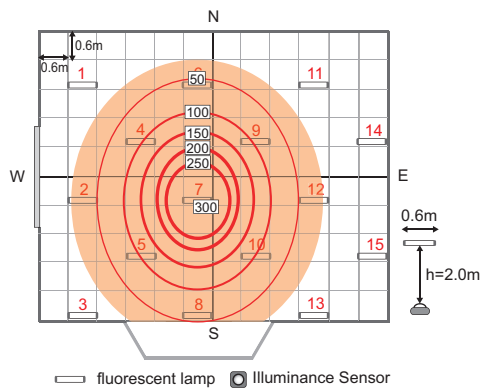

(a) Maximum luminance

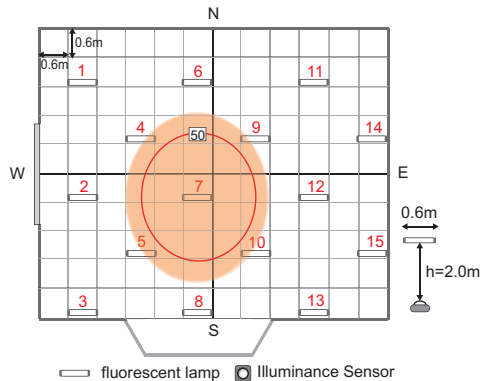

(b) Minimum luminance

Fig. 4. Illuminance distribution.

illuminance is 50[lx] or more when the lights are on at minimum luminance (Fig.4).

2) *Experiment overview:* To verify the validity of VLC, we compared conventional ANA/CC and our proposed method under the following conditions. The environment is a room 6.0[m] wide by 7.2[m] long by 2.7[m] tall, as shown in Fig.5 (an overhead floor plan). Illuminance sensors were placed on desks 0.7[m] tall.

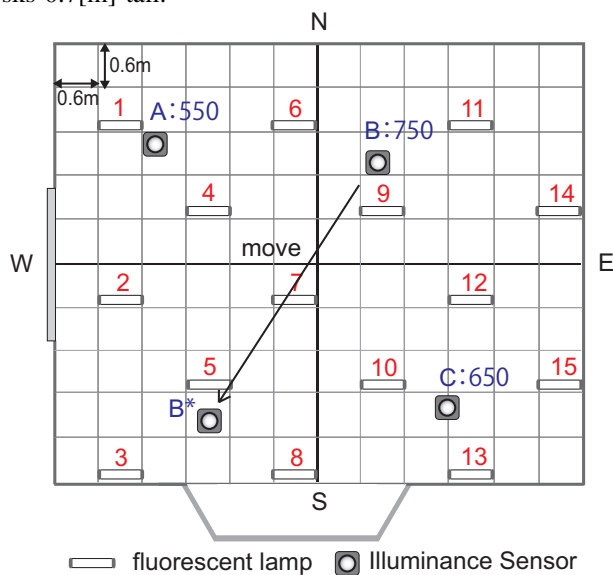

Fig. 5. Experimental environment.

Condition 1

Fixed illuminance sensors Luminance is to converge with illuminance sensors placed at fixed positions shown in Fig.5. Target illuminance values for each sensor is 550[lx] for sensor A, 750[lx] for sensor B, 650[lx] for sensor C.

Condition 2

Illuminance sensor moved After illuminance at sensor B has converged, luminance is to re-converge with sensor B being moved to position B*. Sensor B's original position and target illuminance are identical to those in condition 1. The moving of sensor B starts well after illuminance converges at the original position, and takes 2 seconds to reach the destination.

Table IV shows parameters used for the experiment.

TABLE IV
PARAMETERS OF THE EXPERIMENT.

Type of light source	Fluorescent lamps
Number of fluorescent lamps	15
Number of illuminance sensors	3
Maximum lit luminance[cd]	1320
Minimum lit luminance[cd]	396
Initial lit luminance[cd]	1320
Illuminance retrieval interval[s]	1

3) *Results:* Figs.6 and 7 show the history of illuminance values It has been reported that the human eye cannot recognize illuminance changes that are within ratios 0.92 and 1.06 of the original, so we shall consider illuminance to be converged when values are within this range[7].

Under condition 1(between 0[s] to 200[s]), the conventional method, which computes correlation coefficients by repeatedly making unrecognizable changes in luminance, takes approximately 110[s] to converge. On the other hand, with the proposed method, which communicates the correlation coefficients directly for sensors within VLC range, illuminance converged in approximately 70[s].

We started moving the sensor 200[s](when illuminance had converged sufficiently) afterwards.

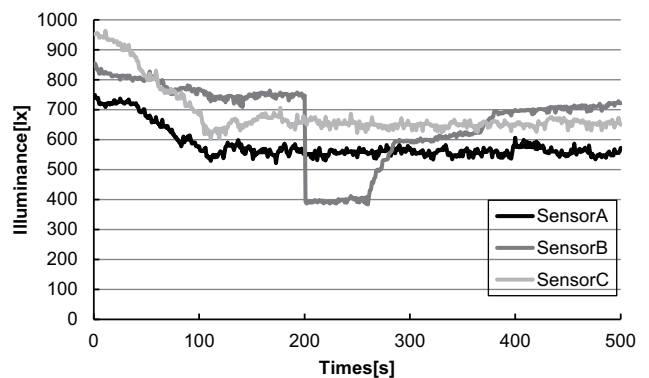

Fig. 6. Illuminance history of the conventional method.

Under condition 2(between 200[s] to 500[s]), the illuminance dropped sharply when the sensor was removed from the original position. The conventional method needed to recalculate the correlation coefficients. This resulted in a slow

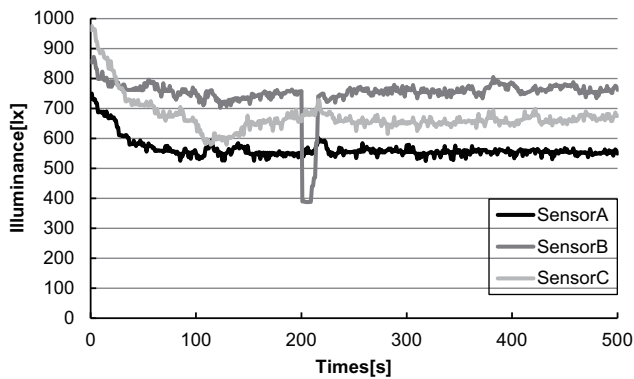

Fig. 7. Illuminance history of the proposed method.

climb of illuminance, then a quick convergence once the coefficients are found.

The proposed method used VLC to estimate the spatial relationships, and executed rapid brightening accordingly. The illuminance climbed to meet the target approximately 10[s] after the sharp drop.

The above results show us that the proposed system can adapt quickly to movements of illuminance sensors.

V. CONCLUSIONS

The conventional control algorithm for the Intelligent Lighting System, ANA/CC (Adaptive Neighborhood Algorithm using Correlation Coefficient) is able to satisfy users' required illuminance by computing correlation coefficients based on the lights' luminance changes and the sensors' illuminance changes. The time this algorithm takes to converge to the target illuminance is approximately 2 minutes, of which the time to compute the correlation coefficients is a large factor.

In this study, we proposed a system that uses VLC (visible light communication) to estimate the lights' and sensors' spatial relationships. We proposed a new lighting control algorithm that uses this VLC method and verified its validity using an experimental setup.

In the experiment, we made illuminance converge for a sensor, set its target illuminance to a high value, and moved the sensor to an underlit spot. Our new Intelligent Lighting System was able to light up the destination in approximately 10[s] after the sensor was moved. Power consumption converged to roughly the same value as the conventional method. Our new method has improved significantly on the conventional Intelligent Lighting System in terms of the speed of convergence.

REFERENCES

- [1] M.Miki,T.Hiroyasu,K.Imazato,Proposal for an intelligent lighting system,and verification of control method effectiveness,Proc IEEE CIS,pp.520-525,2004,
- [2] M.Miki,K.Imazato,M.Yonezawa,Intelligent lighting control using correlation coefficient between luminance and illuminance,Proc.IASTED Intelligent Systems and Control,Vol.497,No.078,pp.31-36,2005
- [3] M.Miki,T.Hiroyasu,K.Imazato,Intelligent Lighting Control using Correlation Coefficient between Luminance and Illuminance,IASTED ISC,No.497-078,2005
- [4] F.Kaku,*et al.*,Construction of Intelligent Lighting System Providing Desired Illuminance Distributions in Actual Office Environment,Artificial Intelligence and Soft computing,Vol.611,pp.451-460,2010

- [5] D.C.O'Brien, and L.Zeng and H.Le-Minh and G.Faulkner and J.W.Walewski and S.Randel,Personal, Indoor and Mobile Radio Communications, 2008. PIMRC 2008. IEEE 19th International Symposium on, Visible light communications: Challenges and possibilities, pp.1 - 5,2008
- [6] M.Yoshino,S.Haruyama,M.Nakagawa, Radio and Wireless Symposium, 2008 IEEE,High-accuracy positioning system using visible LED lights and image sensor, pp.439 -442,2008
- [7] T.Shikakura, H.Morikawa, and Y.Nakamura,Research on the Perception of Lighting Fluctuation in a Luminous Offices Environment,Journal of the Illuminating Engineering Institute of Japan, Vol.85 5, pp.346-351,2001