

# An Evolutional Optimization Algorithm to Provide Individual Illuminance in Workplaces

Shingo Tanaka  
Graduate School of Engineering  
Doshisha University  
Kyoto, Japan  
stanaka@mikilab.doshisha.ac.jp

Mitsunori Miki  
Department of Science and Engineering  
Doshisha University  
Kyoto, Japan  
mmiki@mail.doshisha.ac.jp

Tomoyuki Hiroyasu  
Department of Life and Medical Sciences  
Doshisha University  
Kyoto, Japan  
tomo@is.doshisha.ac.jp

Mitsuharu Yoshikata  
Graduate School of Engineering  
Doshisha University  
Kyoto, Japan  
myoshikata@mikilab.doshisha.ac.jp

**Abstract**—We are doing research and development of an intelligent lighting system to provide individual illuminance in workspace. In the intelligent lighting system, the algorithm which controls lighting fixtures is important. In this research, we examine how to grasp the factor of influence on illuminance sensors for lighting, and we propose a lighting control algorithm which estimates precisely the factor of influence on illuminance sensors for lighting by using the regression analysis. We show the effectiveness of such an algorithm. We show also the effectiveness of the algorithm in an actual workspace.

**Index Terms**—Intelligent, lighting systems, autonomous distributed control, energy saving, regression coefficient

## I. INTRODUCTION

In recent years, continuing research into the office environment has identified that the office environment has a major influence on workers. Previous research has reported that improving the office environment can increase workers' intellectual productivity and comfort[1], [2]. With regard to the lighting environment, it has also been reported that providing each worker's desired brightness can raise intellectual productivity[3].

However, at present, the standard lighting design of Japanese offices features a desktop illuminance of 750 lx or greater. Consequently, this cannot be considered a lighting environment suited to each worker. Furthermore, it is also believed that desired illuminance differs by race and culture. For all these reasons, we have been researching into an intelligent lighting system in order to provide individual illuminance environments in our laboratory[4], [5]. An intelligent lighting system provides each user's desired illuminance, and also gives energy saving.

Adaptive Neighborhood Algorithm using Correlation Coefficient (ANA/CC)[5] has been proposed as a control algorithm for intelligent lighting systems. This algorithm is based on Hill Climbing(HC). It uses correlation coefficients to apprehend the factor of influence to illuminance sensors of the lighting, and to efficiently bring about changes in luminance.

It has been previously shown that ANA/CC is capable of stable convergence of illuminance. However, under ANA/CC a detailed understanding of the aforementioned factor of influence is not easily achieved, the luminance of the lighting changes complementarily, and the lighting state can sometimes seem strange to the human eye.

On one hand, this previously proposed intelligent lighting system was demonstrated to perform well in the laboratory. However, no substantiated experiments had been undertaken in an actual office workspace. There was a consequent need for evaluation over the long term by users of an intelligent lighting system.

Given all these factors, in this paper we propose a control algorithm that enables more precise estimation of the factor of influence to illuminance sensors of lighting, and to demonstrate the effectiveness of such an algorithm. We also conducted experiments to evaluate the performance of the intelligent lighting system in an actual office workspace and to verify its effectiveness.

## II. INTELLIGENT LIGHTING SYSTEM

### A. Overview of the intelligent lighting system

The intelligent lighting system, as indicated in Fig. 1, is composed of lights equipped with microprocessors, portable illuminance sensors, and electrical power meters, with each element connected via a network.

Individual users set the illuminance constraint on the illuminance sensors. At this time, each light repeats autonomous changes in luminance to converge to an optimum lighting pattern. Also, with the intelligent lighting system, positional information for the lights and illuminance sensors is unnecessary. This is because the lights learn the factor of influence to the illuminance sensors, based on illuminance data sent from illuminance sensors. In this fashion, each user's target illuminance can be provided rapidly.

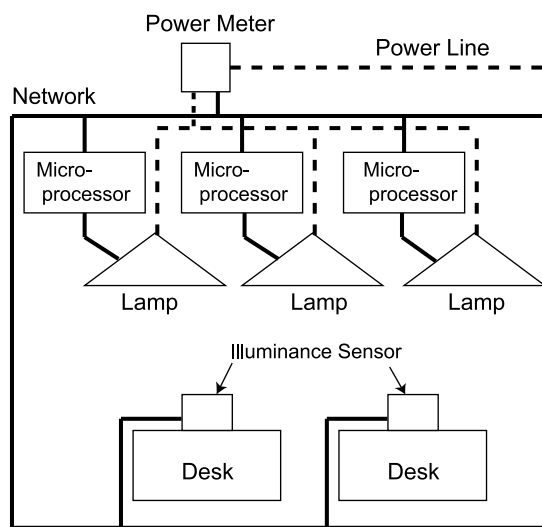

Fig. 1. Configuration of Intelligent Lighting System

The most significant feature of the intelligent lighting system is that no component exists for integrated control of the whole system; each light is controlled autonomously. For this reason, the system has a high degree of fault tolerance, making it highly reliable even for large-scale offices.

#### B. Formulation as an optimization problem

The purpose of the intelligent lighting system is to achieve each user's desired illuminance, and to minimize energy consumption. Thus, it can be understood as an optimization problem in which each light optimizes its own luminance. Following from this, the luminance of each light is considered a design variable, under the constraint of the user's target illuminance, in resolving the problem of optimization to minimize energy consumption. For this reason, the objective function is set as in Eq. (1).

The objective function was derived from amount of electric power  $P$  and illuminance constraint  $g_j$ . Also, changing weighting factor  $w$  enables changes in the order of priority for electrical energy and illuminance constraint. The illuminance constraint brings current illuminance to target illuminance or greater, as indicated by Eq. (2).

$$f = P + w \sum_{j=1}^n g_j \quad (1)$$

$$g_j = \begin{cases} 0 & 0 \leq (Lc_j - Lt_j) \\ (Lc_j - Lt_j)^2 & (Lc_j - Lt_j) < 0 \end{cases} \quad (2)$$

$P$ : amount of electric power,  $w$ : weighting factor,  $Lc$ : current illuminance,  $Lt$ : target illuminance

#### C. Control algorithm for the intelligent lighting system (ANA/CC)

The intelligent lighting system used an algorithm based on the general purpose optimization method called Hill Climbing. Furthermore, with this algorithm, the factor of influence on

lighting for each illuminance sensor was estimated and to efficiently bring about changes in luminance, depending on circumstances. This was called ANA/CC (Adaptive Neighborhood Algorithm using Correlation Coefficient). The flow of ANA/CC is indicated below.

- 1) Each lighting lights up by initial luminance.
- 2) Each illuminance sensor transmits illuminance information (current illuminance, target illuminance) to the network. The electrical power meter transmits power consumption information to the network.
- 3) Each lighting acquires the information from step 2, and conducts evaluation of objective function for current luminance.
- 4) Neighborhood is determined, which is the range of change in luminance based on factor of influence and illuminance information.
- 5) The next luminance within the neighborhood is randomly generated, and the lighting lights up by that luminance.
- 6) Each illuminance sensor transmits illuminance information to the network. The electrical power meter transmits power consumption information to the network.
- 7) Each light acquires the information from step 6, and conducts evaluation of objective function for next luminance.
- 8) If the objective function value is improved, the next luminance is accepted. If this is not the case, the lighting returns to the original luminance.
- 9) Steps 2~9 are one search operation of the luminance value, which is repeated.

Through repetition of the above actions, each light learns the factor of influence for each illuminance sensor, each user's target illuminance is provided, and energy consumption is reduced. Furthermore, the time required for each search operation is around 1 second. The abovementioned repetitions return to step 2 instead of step 5 (conducting evaluation of objective function once more) in order to allow for any changes in environment.

#### D. Neighborhood design

With a general Hill Climbing, next luminance is randomly generated while objective function is minimized. Subsequently, the neighborhood for each variable, which is the range of next luminance generation used at this time, is fixed. However, using this sort of fixed neighborhood markedly increases the number of repeated search operations, such that convergence of illuminance becomes very slow. For this reason, the neighborhood (range of next luminance generation) is adaptively determined with ANA/CC. That is, when it is necessary to increase the luminance of a given light, a neighborhood is used that tends toward increased luminance. Conversely, when it is necessary to decrease the luminance of a given light, a neighborhood is used that tends toward decreased luminance.

As indicated in Fig. 2, three types of neighborhoods are used in ANA/CC: (A) neighborhood for luminance decrease; (B) neighborhood for luminance adjustment, and; (C) neighborhood for luminance increase. The values indicated in Fig.

2 represent the amount of change in luminance for the lights when set to operate at 100% luminance.

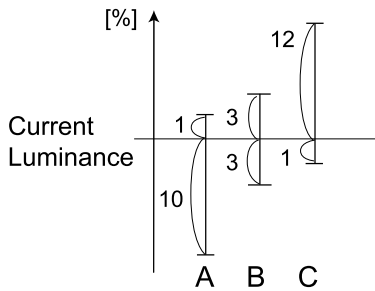

Fig. 2. Three types of the neighborhood

For each lighting, neighborhood  $N_i$  for illuminance sensor  $i$  is determined using the following rules, based on the factor of influence to each illuminance sensor and the illuminance values of the illuminance sensors.

$$N_i = \begin{cases} A & r_i < \text{threshold} \\ B & r_i \geq \text{threshold} \text{ and } Lc \geq Lt \\ C & r_i \geq \text{threshold} \text{ and } Lc < Lt \end{cases}$$

Here,  $r_i$  indicates the correlation coefficient for illuminance sensor  $i$ ,  $\text{threshold}$  indicates the threshold value for the correlation coefficient for judging the existence or non-existence of influence,  $Lc$  indicates current illuminance, and  $Lt$  indicates target illuminance.

After neighborhood  $N_i$  is determined for each illuminance sensor, the neighborhood  $N_i$  with the highest tendency toward increased luminance is set as that lighting's neighborhood.

Using these rules, for those lightings with lower factor of influence to the illuminance sensors, luminance is reduced. Conversely, for those lightings with higher factor of influence, luminance adjustment is performed so as to achieve target illuminance for the illuminance sensors that they influence.

#### E. Experimental results using ANA/CC

We evaluate ANA/CC using an intelligent lighting system constructed in the laboratory. The experimental environment is shown in Fig. 3. The experiment used 3 illuminance sensors. Target illuminances were set at 750, 700, and 800lx for illuminance sensors A, B, and C. Also, illuminance sensor A is moved after 500 steps. The illuminance history obtained from the experiment results is indicated in Fig. 4, and the luminance histories of lightings 7, 8, 9, 12, 13, and 14 (which influenced Illuminance Sensor A before move) are indicated in Fig. 5.

It can be observed from Fig. 4 that the illuminance of each illuminance sensor converged on the target illuminance. Furthermore, it can be observed that even when the illuminance sensor is moved, the illuminance converged on the target illuminance after the move. From these findings, we can see that positive results were obtained. However, we can also observe from Fig. 5 that the luminance of the lightings in the area around illuminance sensor A was both unstable. From

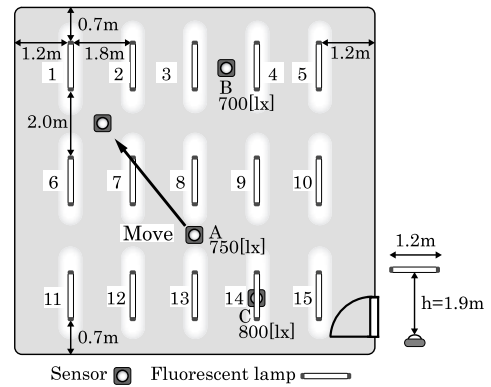

Fig. 3. Experiment environment

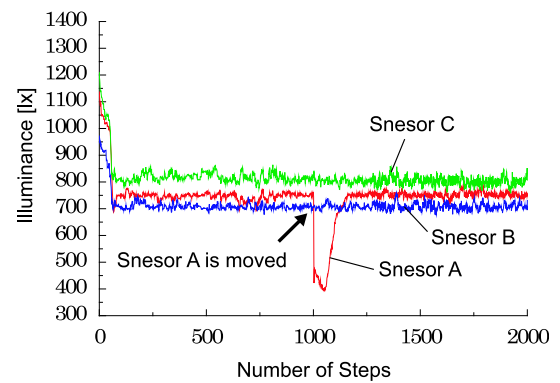

Fig. 4. History of illuminance(ANA/CC)

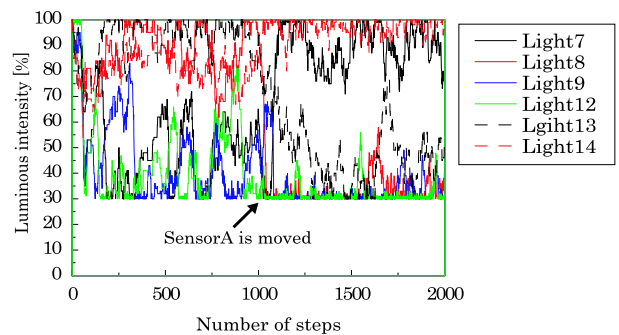

Fig. 5. History of luminance(ANA/CC)

Fig. 4 and Fig. 5, we can observe that illuminance in the location of the illuminance sensor was stable, but also that the lightings influencing this were acting complementarily. Specifically, whenever some lightings increased the luminance, others decreased the luminance. This was not a problem for the performance of work tasks, but when these lights were observed, these subtle changes in luminance seemed to impart a slight sense of strangeness to the human eye. To solve this problem, we propose a new algorithm intended to stabilize not only illuminance, but also luminance.

### III. ADAPTIVE NEIGHBORHOOD ALGORITHM USING REGRESSION COEFFICIENT

#### A. Estimating factor of influence using regression coefficients

The purpose of the intelligent lighting system is to provide individual illuminance, as well as to rapidly achieve a state of low power consumption. Consequently, it is very important to know the factors of influence to illuminance sensor of lighting. To this end, ANA/CC uses correlation coefficients for change in the luminance of the lights and change in illuminance of the illuminance sensor to estimate factor of influence. However, detailed understanding of the respective factors of influence cannot be achieved using these correlation coefficients. Thus, in order to estimate factor of influence to illuminance sensors of lighting, regression analysis was used. Regression analysis is a method that analyzes the cause-and-effect relationship between two variables: examining how observed value  $y$  also changes when explanatory variable  $x$  is subjected to change. A cause-and-effect relationship is sought by approximating the functions of explanatory variable  $x$  and observed value  $y$  using a regression equation as indicated in Eq. 3.

$$y_i = \beta_0 + \beta_1 x_i \quad (3)$$

The Serially Least Square technique was used here for regression analysis. This method estimates the regression coefficients recursively in the search process. Using the Serially Least Square technique, estimation of the regression coefficient  $\beta$  was conducted following the sequence below. The current search step is indicated by  $k$ .

- 1) Calculate covariance of error of measurement prediction  
 $S(k) = x(k)P(k-1)x(k) + R(k)$
- 2) Calculate filter gain  
 $W(k) = P(k-1)x(k)S^{-1}(k)$
- 3) Calculate covariance of error of estimation  
 $P(k) = P(k-1) - W(k)S(k)W(k)$
- 4) Calculate prediction of observation  
 $\hat{y}(k) = x(k)\beta(k-1)$
- 5) Calculate error of measurement prediction  
 $\epsilon(k) = y(k) - \hat{y}(k)$
- 6) Calculate estimation  
 $\beta(k) = \beta(k-1) + W(k)\epsilon(k)$

Here, regression analysis was performed with the amount of change in luminance for one luminance value search represented by  $x$ , and amount of change in illuminance represented by  $y$ . As a result, distribution and regression line were obtained as indicated in Fig. 6. Also, Fig. 6 shows results of regression analysis for sensor A and sensor B with regard to lighting A. The variations in the distribution of luminance and illuminance were generated due to influence from changes in luminance of other lightings. However, by calculating the regression line, a regression coefficient  $\beta$  (gradient) specific to the factor of influence of lights and illuminance sensors was successfully obtained.

In order to compare the precision of correlation coefficients with that of regression coefficients, a comparative experiment

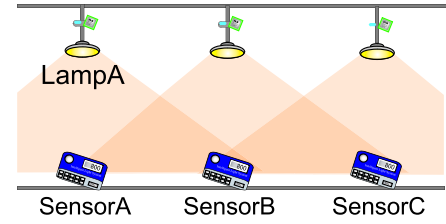

(a) Experiment environment for regression coefficient

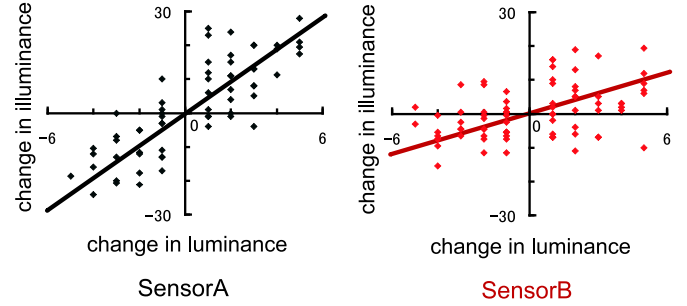

(b) Regression Line

Fig. 6. The regression line according to the distance

was conducted in the environment indicated by Fig. 6-(a). Correlation coefficient history (for lighting A with regard to sensors A, B, and C) is indicated in Fig. 7-(a), while regression coefficient history is indicated in Fig. 7-(b).

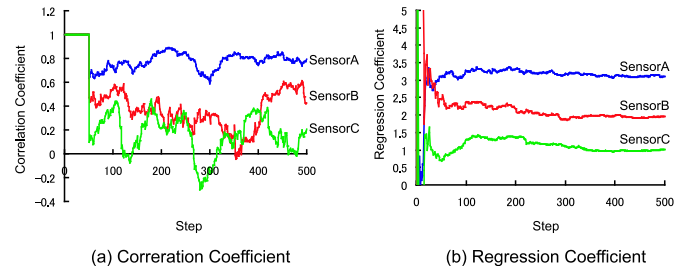

(a) Correlation Coefficient

(b) Regression Coefficient

Fig. 7. History of the factor of influence

As seen in Fig. 7, it was found that with correlation coefficients, the magnitude correlation of sensors B and C exchanged, and details of the factors of influence could not be obtained. This was responsible for generating the unstable luminance phenomena observed in the previous results. Conversely, with regression coefficients, it was verified that stable values specific to the factors of influence could be obtained. Accordingly, it was concluded that use of regression coefficients enables a more detailed understanding of the factors of influence to the illuminance sensor of lightings.

#### B. Improving neighborhood design

1) *Classifying factor of influence:* By using regression coefficients, this algorithm enables a more detailed understanding of the factors of influence to the illuminance sensor

of lightings. Since this also enables precise neighborhood design according to the factor of influence, we investigated the possibility of classifying the factors of influence. Given the installation intervals of normal office lightings, when a lighting is located directly above the illuminance sensor it exerts a strong factor of influence, while the influence of adjacent lightings is around half that. This relationship between the position of lights and the factor of influence is indicated in Fig. 8. Also, percentages were also utilized for factors of influence, whereby the factor of influence of lightings located directly above the sensor was considered as 100%.

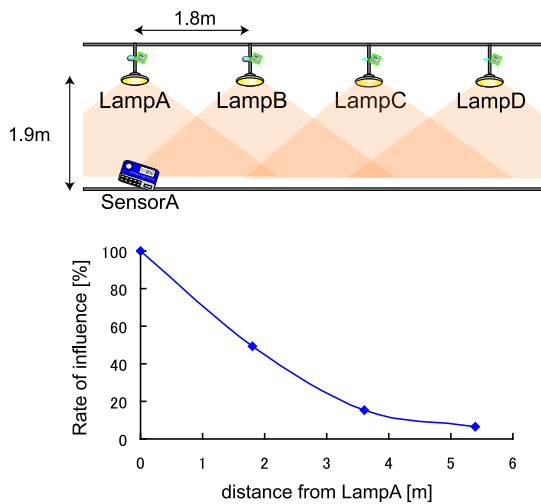

Fig. 8. Relation between position and influence

From Fig. 8, it can be seen that factor of influence decreases as a light's position moves further away from the light located directly above the illuminance sensor. A light fixture located 3 intervals away from one directly above the illuminance sensor had a factor of influence of 10% or less. From this finding, we believed that classifying the factor of influence of lights and illuminance sensors into 4 categories was appropriate. It was possible to classify the factor of influence into 4 categories: High, Medium, Low, and No influence.

2) *Determining neighborhood*: Neighborhood (the range of change in luminance of lightings) was implemented as three types of neighborhoods, as indicated in Fig. 2: neighborhood for luminance increasing, neighborhood for luminance decreasing, and neighborhood for luminance adjustment. Which of these neighborhoods to use was determined by current illuminance and target illuminance. When current illuminance was lower than target illuminance, the neighborhood for luminance increasing was used; conversely, when current illuminance was higher than target illuminance, the neighborhood for luminance decreasing was used. Also, since there were 4 categories of factor of influence, as mentioned previously, it was necessary to assign neighborhoods depending on factors of influence. This is because when current illuminance was lower than target illuminance, it was more effective to increase the luminance of lightings with a greater factor of influence. Conversely, in cases

where current illuminance was higher than target illuminance, assigning a neighborhood for luminance decreasing to lightings with a greater factor of influence meant that target illuminance was achieved using lightings with a lesser factor of influence. This contributed to increased power consumption. For this reason, in cases when it is necessary to decrease luminance, this luminance decrease must be implemented from lightings with a lesser factor of influence.

Taking these factors into consideration when designing neighborhoods, it is thus possible to move beyond the 3 conventional categories of luminance increase, luminance decrease, and luminance adjustment(AD). Luminance increase can be further categorized into rapid luminance increase (RI), medium-pace luminance increase (MI), and slow luminance increase (SI). In the same fashion, luminance decrease can be further categorized into rapid luminance decrease (RD), medium-pace luminance decrease (MD), and slow luminance decrease (SD). Given these finer distinctions, a total 7 categories of neighborhood can be presumed. 1 neighborhood is determined from among these 7 neighborhood categories, depending on factor of influence and the illuminance value.

As described previously, there are 4 categories of factor of influence. Illuminance is also classified into 4 categories, depending on whether current illuminance is Too High, High, Low, and Too Low with regard to target illuminance. Neighborhood  $N_i$  for illuminance sensor  $i$  is determined, with reference to Table. I, from each light's factor of influence for the illuminance sensor and illuminance value. Subsequently, after neighborhood  $N_i$  is determined, the neighborhood with the highest tendency toward increased luminance is set as that light's neighborhood.

TABLE I  
NEIGHBORHOOD DECISION

	the illuminance value			
	Too high	High	Low	Too low
High Influence	LD	AD	MI	RI
Middle Influence	MD	LD	LI	MI
Low Influence	RD	MD	AD	LI
No Influence	RD			

A neighborhood actually utilized this algorithm is indicated in Fig. 9.

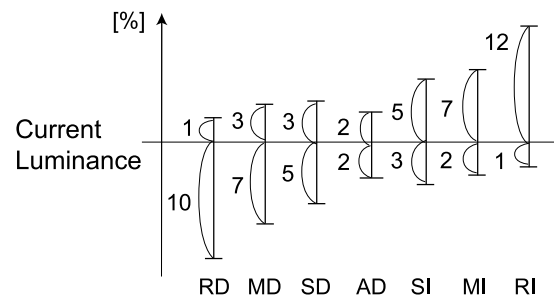

Fig. 9. Seven types of the neighborhood

### C. Verification experiment

We performed verification of the validity of the proposed algorithm. Hereafter, the proposed algorithm is called Adaptive Neighborhood Algorithm using Regression Coefficient(ANA/RC). The experiment was conducted in the environment indicated by Fig. 3. The experiment used 3 illuminance sensors. Target illuminances were set at 750, 700, and 800lx for illuminance sensors A, B, and C. Also, illuminance sensor A is moved after 500 steps. The illuminance history obtained from the experiment results is indicated in Fig. 10, and the luminance histories of Lightings 7, 8, 9, 12, 13, and 14 (which influenced Illuminance Sensor A before its shift) are indicated in Fig. 11.

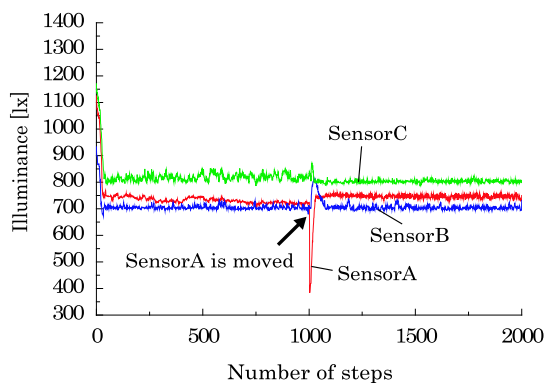

Fig. 10. History of illuminance(ANA/RC)

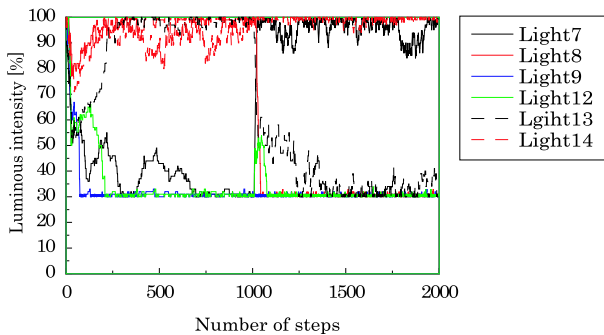

Fig. 11. History of luminance(ANA/RC)

From Fig. 4 and Fig. 10, it can be seen that ANA/RC and ANA/CC shared a similar level of stability of illuminance. It was also found that illuminance converged on the target around 20 steps faster with the ANA/RC algorithm than with ANA/CC. After Illuminance Sensor A is moved, illuminance converged on the target around 100 steps faster with the ANA/RC algorithm. However, with ANA/RC, after Illuminance Sensor A shifted location, the illuminance of locations with other illuminance sensors was higher than the target illuminance. This was believed to occur because many lightings were using a neighborhood for luminance increasing at a stage where factor of influence had not been correctly

estimated. From Fig. 5 and Fig. 11, it can be observed that the luminance of each light was more stable under the ANA/RC algorithm by comparison with ANA/CC.

From all these observations, it was found that, in comparison with ANA/CC, the ANA/RC algorithm provided faster convergence with a similar level of stability of illuminance. Furthermore, it was found that luminance stability, which had been a problem with ANA/CC, also increased due to the more detailed understanding of factor of influence achieved with ANA/RC.

## IV. INVESTIGATION OF EFFECTIVENESS OF INTELLIGENT LIGHTING SYSTEM IN REAL ENVIRONMENTS

### A. Overview of experiment

Up to this point, this system had been subjected to a wide variety of experiments in a laboratory environment featuring 15 fluorescent lights. This meant that demonstrative experimentation in an actual working environment was now an issue to address. Thus, we constructed an intelligent lighting system in an actual office workspace, and investigated its effectiveness.

As Fig. 12 indicates, we installed temporary ceilings in the student's room in the laboratory. We then installed 10 fluorescent lights with a dimming range from 17% to 100% and constructed an intelligent lighting system. Test subjects were 10 students ranging from 21 to 25 years of age, who went about their work tasks as usual within the facility. The experiment was conducted for 2 months. During the experiment, the test subjects freely set illuminance to the level most conducive to their own work tasks.

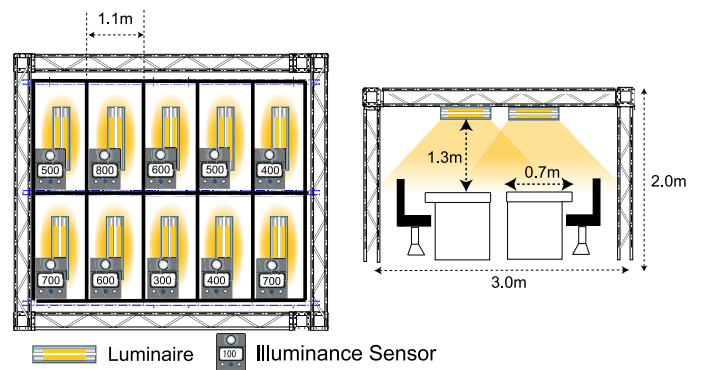

Fig. 12. Experiment institution at actual workspace

### B. Experimental results and observations

Fig. 13 indicates target illuminance of each test subject, luminance, and illuminance distribution. Fig. res in parentheses indicate target illuminance for each illuminance sensor. These values were determined by trial-and-error at the beginning of the experiment period, taking the illuminance that each test subject felt was optimal.

Fig. 13 indicates that target illuminance for each test subject fell between maximum 800 lx and minimum 200 lx. As a result, the illuminance levels that 10 test subjects felt were optimal for the performance of work tasks were found to

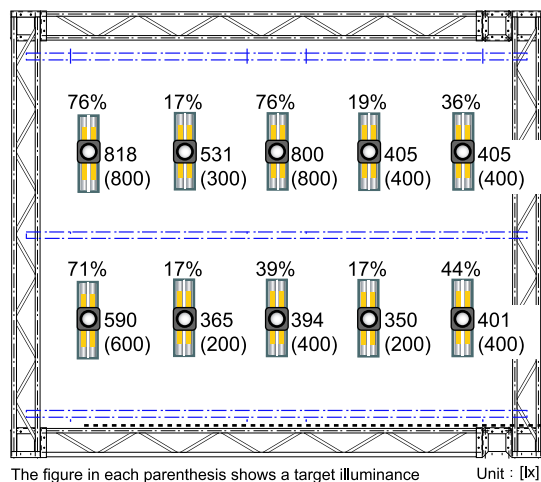

Fig. 13. Distribution of the luminance and illuminance

differ widely. With regard to the illuminance provided by the intelligent lighting system, and excluding those subjects who set very low target illuminance levels (300 lx or below), the margin of error between each test subject's current illuminance and their target illuminance was 18 lx or less. Thus, it can be seen that a value very close to each user's desired target illuminance was achieved. Also, for those test subjects with target illuminance set so low as to be unachievable, the luminance of the lights situated closest to them was set at the minimum of 17%. It could be argued, then, that this successfully confirmed that target illuminances were achieved to the extent that this system allowed. In locations where target illuminance was 800 lx or 600 lx, lights were operating at comparatively high luminance settings of 71% to 76%. In locations where lighting was not required, lightings operated at the approximate minimum setting of 17%. All these observations confirm that an appropriate lighting operation pattern, mindful of low energy consumption considerations, was successfully achieved. Also, with regard to differentials between adjacent target illuminances, in high illuminance locations (with surroundings at 800 lx), differentials around the 200 lx were achieved. However, in locations with surroundings of low illuminance, since luminance values were approaching the lower limit of dimming for the lighting apparatus, differentials was around the 100 lx. Use of lighting apparatus with a wider dimming range could solve this problem.

Fig. 14 indicates average values for energy consumption during the experimental period. These figures use average energy consumption values for each day during the 12-hour period between 10am and 10pm. At present, a standard desktop illuminance of 750 lx is recommended in most Japanese offices. In actual offices, considering that fluorescent lights deteriorate over time, initial illuminance levels around 1000 lx are commonly achieved. This paper assumes an ongoing process of deterioration for fluorescent lights, and accordingly sets an illuminance of 800 lx as a standard value for electrical energy.

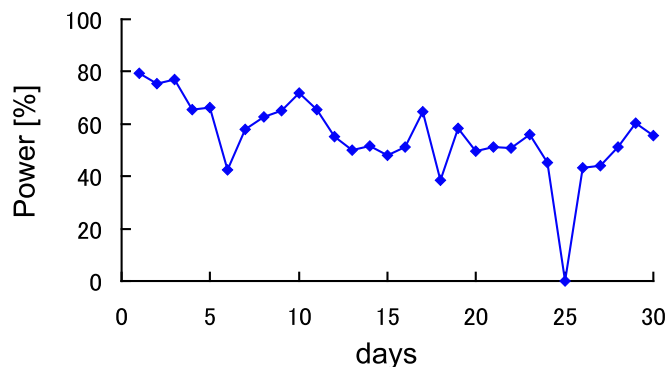

Fig. 14. Daily power consumption

From Fig. 14, it can be seen that long-term use of an intelligent lighting system can reduce energy consumption by 40~50% compared to conventional lighting environments.

## V. SUMMARY

Until now, control algorithms used for intelligent lighting systems were optimization algorithms that utilized correlation coefficients for changes in luminance of lights and changes in illuminance of illuminance sensors. This study proposed a new algorithm utilizing regression coefficients for changes in luminance of lights and changes in illuminance of illuminance sensors. Under this method, stability of luminance was greatly increased. This study also implemented an intelligent lighting system utilizing the proposed algorithm in an actual working environment. As a result, the illuminances that each test subject felt was optimal for the performance of work tasks were found to differ widely, ranging between maximum 800 lx and minimum 200 lx. It was also demonstrated that, in comparison with conventional lighting environments featuring fixed illuminance levels, a reduction in energy consumption of 40~50% could be achieved.

## REFERENCES

- [1] Olli Seppanen, William J. Fisk: A Model to Estimate the Cost-Effectiveness of Improving Office Work through Indoor Environmental Control, Proceedings of ASHRAE, 2005
- [2] M. J. Mendell, and G. A. Heath: Do indoor pollutants and thermal conditions in schools influence student performance? A critical review of the literature, *Indoor Air*, Vol.15, No.1, pp.27-52, 2005
- [3] Peter R. Boyce, Neil H. Eklund, S. Noel Simpson: Individual Lighting Control: Task Performance, Mood, and Illuminance, *JOURNAL of the Illuminating Engineering Society*, pp.131-142, Winter 2000
- [4] M.Miki: An Intelligent Lighting System and the Consortium for Smart Office Environment, *Journal of Japanese Society for Artificial Intelligence*, Vol.22, No.3, pp.399-410, 2007 (in Japanese)
- [5] Miki M, Hiroyasu T, Imazato K, Yonezawa M: Intelligent Lighting Control using Correlation Coefficient between Luminance and Illuminance, *Proc IASTED Intelligent Systems and Control*, Vol.497, No.078, pp.31-36, 2005